

# **RAILEX** Corporation

## **ELECTRIC GARMENT STORAGE AND RETRIEVAL CONVEYORS** *for Clothing, Garments and Uniforms*

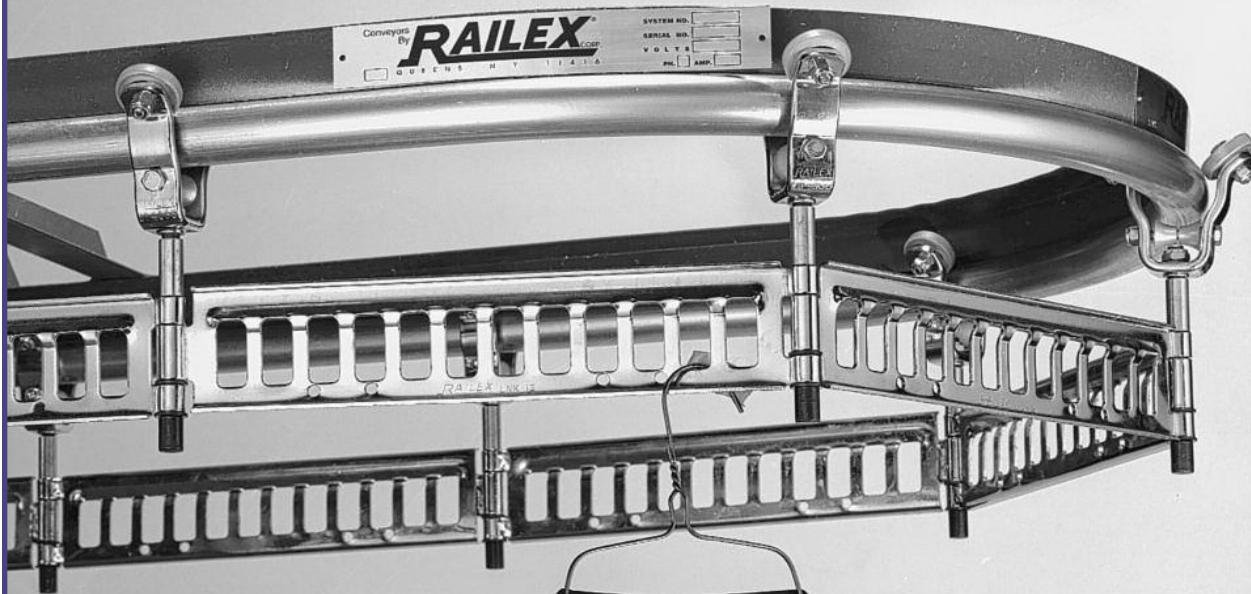

The Systems 722-922 is an electric rack activated by remote controls, either hand or foot, or by a Railex "Robot-Matic" Selector. The position corresponding to the attendant within seconds.

A Railex has many advantages, First is speed. No longer do attendants have to run up and down aisles carrying garments and looking for numbers. One just presses a number and in a few seconds the garments are at the attendants position. Space is another factor. By actual measurements 33% of existing space is saved and becomes available for other purposes. Aisle space is eliminated.

SYSTEM 722-922 5.10

# ELECTRIC GARMENT STORAGE & RETRIEVAL CONVEYORS

## STANDARD FEATURES

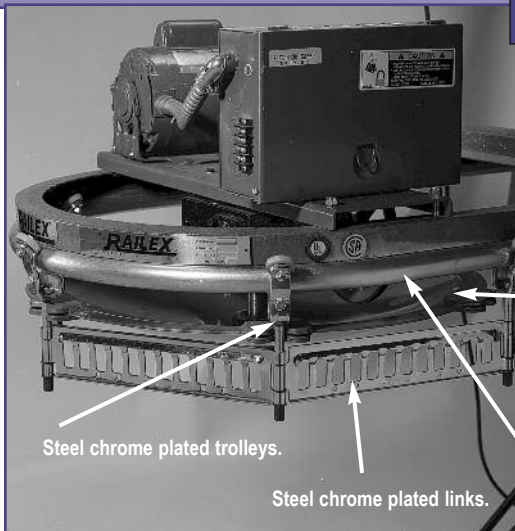

Quiet, noiseless, fast operation. Built in overload protection. Electrical and mechanical interlock Pilot Light. Completely prewired, ready for supply connection.

Chainless drive.

Full frame suspension completely encircles rail for rigidity and safety. Sealed bearings and drive do not require further lubrication.

Steel chrome plated trolleys.

Steel chrome plated links.

## STANDARD EQUIPMENT

**Standard Finishes:** Chrome plated hanger bracket link & trolley, Frame-Black.

**Electrical:** 1/4-3/4 hp.; 115 Volt; 1 Phase.

**Controls:** B-Directional; 1 furnished, hand or foot, includes connecting cables.

**Pilot Light:** To indicate electrical power.

**Supports:** Floor stands & uprights are included for all models except normally ceiling hung sections of Systems 771 & 781.

**Numbering:** Consecutive, last 2 digits, alphabetical, or blank. Specify.

**Approvals:** Underwriters Laboratories (UL) No. E31853.



Flared large area base provides sturdy support, good appearance, easy floor maintenance.

## SYSTEM 722

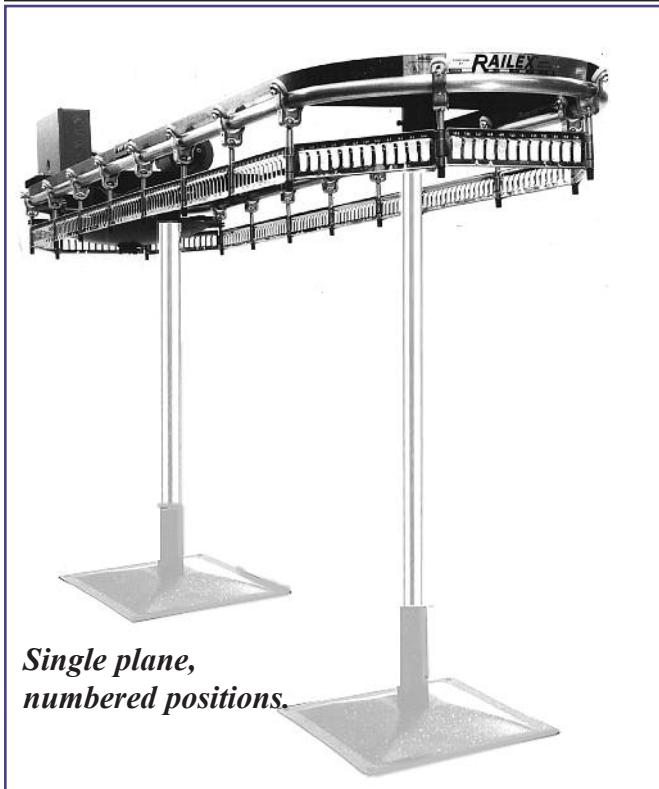

Single plane, numbered positions.

## SYSTEM 724/725



System 724, 4 orders per link. System 725, 5 orders per link. Order assembly with combiner plates and invoice clips.

## SYSTEM 730



Single plane, compressible rail without slots. Garments hang on continuous rail permitting consolidation of hung items.

## SYSTEM 922



Combined hangered and folded or packaged goods. Single plane, numbered positions. Bin size: Width 12", Height 24", Depth 15". Two shelves each bin adjustable at 7" or 14". Other bin sizes to order.

shelves each bin adjustable at 7" or 14". Other bin sizes to order.



## STANDARD CONTROLS

Bi-directional. May be mounted from conveyor frame or remotely. NEC CL2 low voltage, includes interconnecting cable and mounting brackets.

*Specify type and mounting.*

**HAND CONTROL**



**FOOT CONTROL**

## OPTIONAL CONTROLS

**Robot-Matic Selectors:** A remote positioning servo-system that permits the attendant to select the desired position on the conveyor. It will automatically direct the conveyor to travel in the shortest direction. Number selected is always visible. 1-9999. Operation is instantaneous.



## SYSTEM 742\*

ARRANGEMENT NUMBER	GARMENT LENGTH		DIMENSION		OVERALL HEIGHT
	UPPER	LOWER	A	B	C
1	SHORT	SHORT	34"	37"	7'-2"
2	SHORT	INTER	34"	45"	7'-10"
3	SHORT	LONG	34"	60"	9'-1"
5	INTER	INTER	42"	45"	8'-6"
5DCL	INTER	INTER	40.5	40.5	8'-2"
6	INTER	LONG	42"	60"	9'-9"
6DCL	INTER	LONG	40.5	60"	9'-7.5"

\* Other Arrangements Available

## SYSTEM 771/781



System 771-End Loading  
System 781-Side Loading

- ◆ Multi-plane, up and down, numbered positions.
- ◆ 45° incline standard. 30° optional

## STANDARD EQUIPMENT

- ◆ Chrome Plated Links & Trolleys
- ◆ Lubrication Free Rollers
- ◆ Hand Control, E-Stop & Mounting Arm
- ◆ Floor Stand & Uprights
- ◆ Wired Ready for Electrical Supply Connection.
- ◆ U.L. Listed & Labeled. E31853

**RAILEX**® Corp.

89-02 Atlantic Avenue, Ozone Park, NY 11416

Tel: (718) 845-5454 ~ Fax: (718) 738-1020

WWW.RAILEXCORP.COM

Number of Positions for Systems		Length of Hanging Capacity	Overall Length with Garments	Number of Positions for System	Length of Hanging Capacity System
722 & 922	771 & 781	722, 922 771, 781	All Systems	742	742
156		14'-1"	8'-0"	312	28'-2"
180		16'-3"	9'-1"	360	32'-6"
204		18'-5"	10'-2"	408	36'-10"
228		20'-7"	11'-3"	456	41'-2"
252		22'-9"	12'-4"	504	45'-6"
276	253	24'-11"	13'-5"	552	49'-10"
300	275	27'-1"	14'-6"	600	54'-2"
324	297	29'-3"	15'-7"	648	58'-6"
348	319	31'-5"	16'-8"	696	62'-10"
372	341	33'-7"	17'-9"	744	67'-2"
396	363	35'-9"	18'-10"	792	71'-6"
420	385	37'-11"	19'-11"	840	75'-10"
444	407	40'-1"	21'-0"	888	80'-2"
468	429	42'-3"	22'-1"	936	84'-6"
492	451	44'-5"	23'-2"	984	88'-10"
516	473	46'-7"	24'-3"	1032	93'-2"
540	495	48'-9"	25'-4"	1080	97'-6"
564	517	50'-11"	26'-5"	1128	101'-10"
588	539	53'-1"	27'-6"	1176	106'-2"
612	561	55'-3"	28'-7"	1224	110'-6"
636	583	57'-5"	29'-8"	1272	114'-10"
660	605	59'-7"	30'-9"	1320	119'-2"
684	627	61'-9"	31'-10"	1368	123'-6"
708	649	63'-11"	32'-11"	1416	127'-10"
732	671	66'-1"	34'-0"	1464	132'-2"
756	693	68'-3"	35'-1"	1512	136'-6"
780	715	70'-5"	36'-2"	1560	140'-10"
804	737	72'-7"	37'-3"	1608	145'-2"
828	759	74'-9"	38'-4"	1648	149'-6"
852	781	76'-11"	39'-5"	1704	153'-10"
876	803	79'-1"	40'-6"	1752	158'-2"
900	825	81'-3"	41'-7"	1800	162'-6"
924	847	83'-5"	42'-8"		
948	869	85'-7"	43'-9"		
972	891	87'-9"	44'-10"		
996	913	89'-11"	45'-11"		
1020	935	92'-1"	47'-0"		
1044	957	94'-3"	48'-1"		
1068	979	96'-5"	49'-2"		
1092	1001	98'-7"	50'-3"		

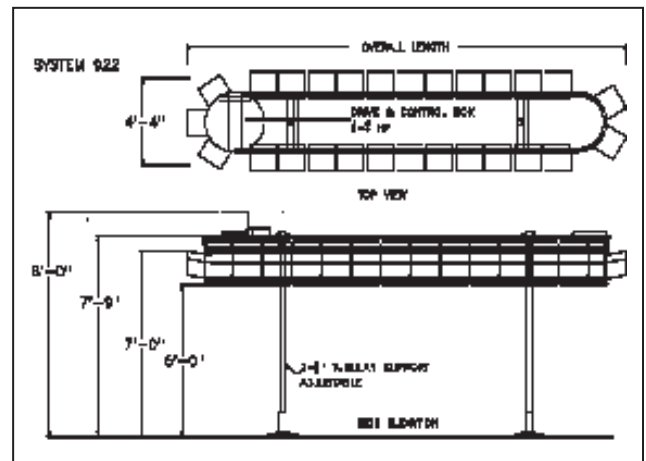
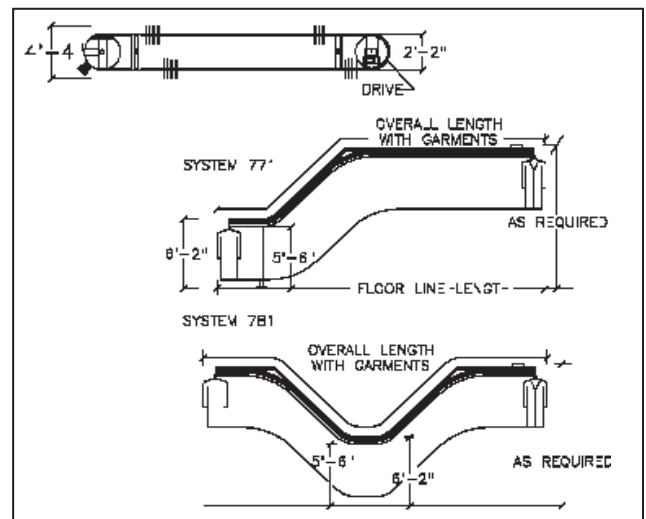
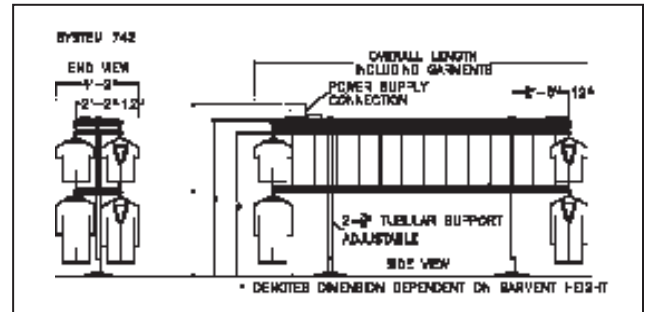
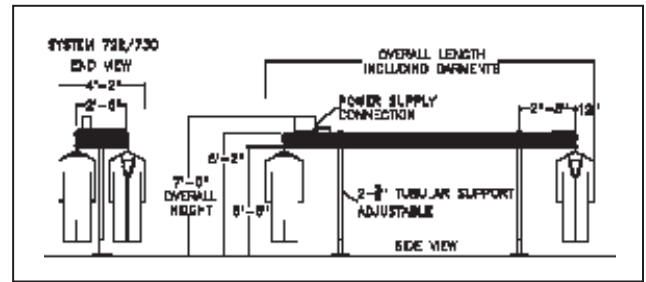

## ORDERING AND SPECIFICATION INFORMATION

Ordering Information: System # \_\_\_\_\_

Size \_\_\_\_\_, Electric Supply \_\_\_\_\_

Control \_\_\_\_\_, Numbering \_\_\_\_\_

1. Frame to completely encircle rail in an endless manner.
2. Floor stands flared, flush, minimum 390 square inches each.
3. Trolley shall be steel & chrome plated.
4. Link & load carrier shall be steel & chrome plated.
5. Drive shall be chainless.
6. Prewired, ready for supply connection.
7. Underwriters Laboratories.